



SHENGHONGYUAN
TRADING

WWW.THENGHONGYUAN.COM



SHENGHONGYUAN
TRADING

SHIJIAZHUANG SHENGHONGYUAN TRADING CO., LTD.

Add: RUICHENG B3-3-1604, NO. 581, ZHONGSHAN(E)ROAD, SHIJIAZHUANG-050000, HEBEI PROVINCE, CHINA.

Tel:86-311-67260671 Fax: 86-311-68010847 Mob:86-13333215543

Website: www.thenghongyuan.com Email: sales@thenghongyuan.com



SHIJIAZHUANG SHENGHONGYUAN TRADING CO.,LTD.

WWW.THENGHONGYUAN.COM

WWW.METAL-THY.COM.CN

About Us

- **Shijiazhuang Shenghongyuan Trading Co., Ltd.** is a manufacture and trade company which is specialized in exporting Metal Art Products, related Mechanical Equipment and Building Metal Products, developing quickly in the fields of Steel Finished Products, such as Gates and Fences as well as Precision Castings and Stainless Steel Pipes & Fittings.
- Cast Grey Iron Components (Fittings) have different styles in more than two hundred sizes in material of grey iron which can be welded by cast iron electrode.
- Cast Steel Components (Fittings), Wrought Iron Ornamental Products and Steel Stamping Components (Fittings) include Spears, Flowers, Leaves, Caps, Collars, Scrolls and Panels in material of low carbon steel class 25-35 which can be easily welded by the steel electrodes.
- Steel Finished Products include Steel Stairs, Steel & Iron Gates, Metal Fences and Candle Holders.
- Mechanical Equipment includes Multifunctional Combination Wrought Iron Machines, Basket Machines and End Scrolling Machines.
- Stainless Steel Pipes & Fittings are widely used in middle or large scale construction projects, such as drinking water, cold and hot water, tap water and gas-supply systems. Stainless steel press fittings (CJ/T152-2001) comply with the industry standards of three national standards (GB/T19228.1-3, 2003).
- By focusing on quality and service, we've been witnessing fast growth and expansion of our customers' businesses year after year. Our goods have been exported to European, South American and the Middle Eastern countries for many years. You are welcome to read our catalogues with the detailed styles and pictures.
- Please do not hesitate to send us your requirements or any special idea. Our production flexibility and diversified range also allow us to fulfill even the smallest overseas order. We will supply you with the best quality for our long term business relations. We hope our metal products sell very well in the international markets.
- At Shijiazhuang Shenghongyuan Trading Co., Ltd., we work hard for mutual success.



01



COMPONENTS

11



GATE AND FENCE

23



STAIRCASE

27



STEEL FURNITURE

33



DOOR HANDLE

35



OTHER

36



01 COMPONENTS

Wrought Iron, flower panel, rosette, balusters

1. Material: Mild Steel

2. Can be welded and galvanized

3. Surface Finish: Antirust oil, Hot-dip galvanized, sandblast

Are hand forged by skilled craftsmen, who have more than ten years experiences. The balusters are made of square bars and round bars, widely used on wrought iron gates, fences and stairs.

Any designs or works along with drawing could also be produced.





SHY-D016



SHY-D017



SHY-D018



SHY-D019



SHY-D020



SHY-D021



SHY-D022



SHY-D023



SHY-D024



SHY-D025



SHY-D026



SHY-D027



SHY-D028



SHY-D029



SHY-D030



SHY-D031



SHY-D032



SHY-D033



SHY-D034



SHY-D035



SHY-D036



SHY-D037



SHY-D038



SHY-D039



SHY-D040



SHY-D041



SHY-D042



SHY-D043



SHY-D044



SHY-D045



SHY-D046



SHY-D047



SHY-D048



SHY-D049



SHY-D050



SHY-D051



SHY-D052



SHY-D053



SHY-D054



SHY-D055



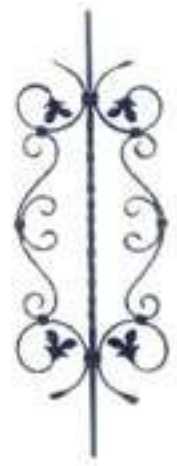

SHY-D056



SHY-D057



SHY-D058



SHY-D062



SHY-D059



SHY-D060



SHY-D061



SHY-D063



SHY-D064



SHY-D065



SHY-D066



SHY-D067



SHY-D068



SHY-D069



SHY-D070



SHY-D071



SHY-D072



SHY-D073

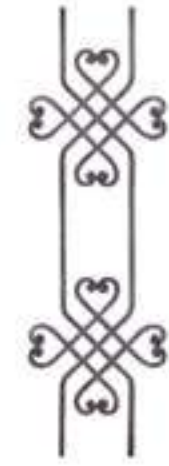

SHY-D074



SHY-D075



SHY-D076



SHY-D077



SHY-D078



SHY-D079



SHY-D080



SHY-D081



SHY-D082



SHY-D083



SHY-D084



SHY-D085



SHY-D086



SHY-D087



SHY-D088



SHY-D089



SHY-D090



SHY-D091



SHY-D092





SHY-D093



SHY-D094



SHY-D095



SHY-D096



SHY-D097



SHY-D098



SHY-D099



SHY-D100



SHY-D101



SHY-D102



SHY-D103



SHY-D104



SHY-D105



SHY-D106



SHY-D107



SHY-D108



SHY-D109



SHY-D110



SHY-D111



SHY-D112



SHY-D113

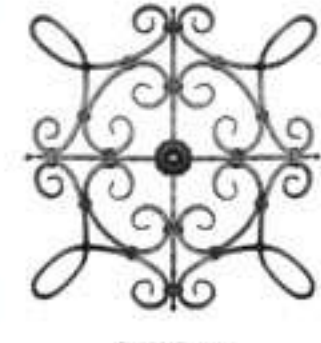

SHY-D114



SHY-D115



SHY-D116

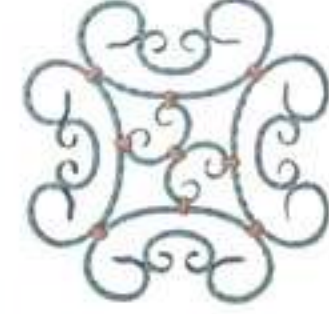

SHY-D117

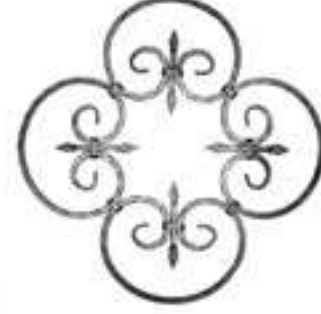

SHY-D118



SHY-D119



SHY-D120



SHY-D121



SHY-D124



SHY-D122

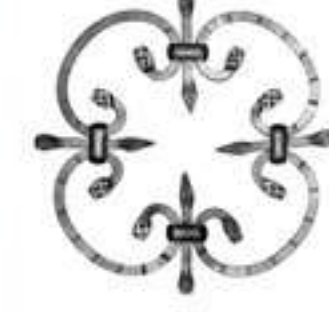

SHY-D123



SHY-D125



SHY-D126



SHY-D127



SHY-D128



SHY-D129



SHY-D130



SHY-D133



SHY-D131



SHY-D132



SHY-D134



SHY-D135



SHY-D136



SHY-D137



SHY-D138

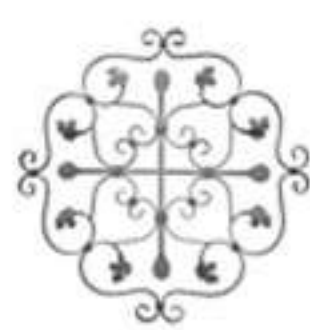

SHY-D139



SHY-D140



SHY-D141



SHY-D142



SHY-D143



SHY-D144



SHY-D145



SHY-D146



SHY-D147



SHY-D148



SHY-D149



SHY-D150



SHY-D151



SHY-D152



SHY-D153



SHY-D154



SHY-D155



SHY-D156



SHY-D157



SHY-D158



SHY-D159



SHY-D160



SHY-D161



SHY-D162





SHY-D165



SHY-D163



SHY-D164



SHY-D166



SHY-D167



SHY-D168



SHY-D169



SHY-D170



SHY-D171



SHY-D172



SHY-D173



SHY-D174



SHY-D175



SHY-D176



SHY-D177



SHY-D178

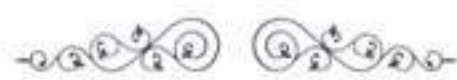

SHY-D179



SHY-D180



02

GATE AND FENCE

1) Material: Wrought Iron.

2) Process: Hand Made.

3) Finish: Hot-dip galvanizing, zinc, powder coating, as customers' requirement.

Gate and Fence are a combination of our hand forged wrought iron components, as basic as simple bars, tubes and beautiful flower panels provides a very sober, however elegant result.

Villa • Garden • Fence • Gate



Installing a wrought iron gate not only provides security and defines a space, but also adds a feeling of elegance and refinement to your yard or garden.



An ornamental and wrought iron fence displays your property's focal points in an elegant fashion and shows off your beautiful, maintained landscapes and well-manicured lawns!

FENCE



We stock the most popular styles and sizes of our wrought iron gates or fences; however, we understand that these may not meet your needs. That's ok because we can accommodate custom designs, different colors, specific sizes and heavier grades.

GATE

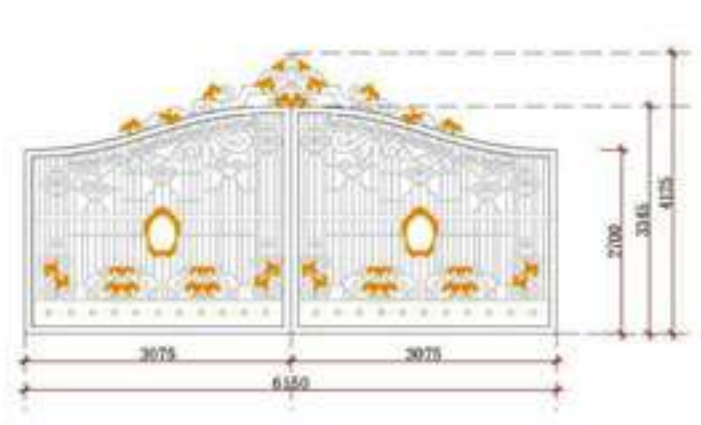

SHY-M00A

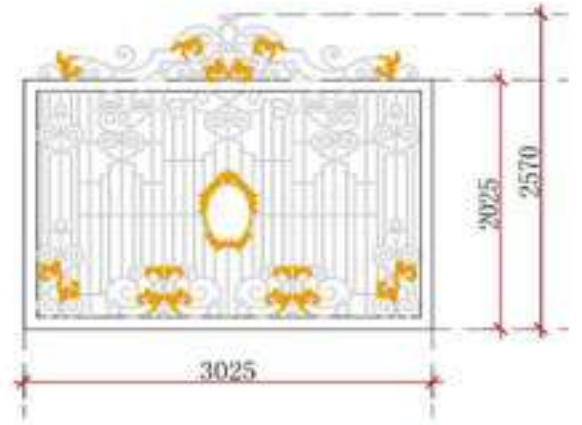

SHY-M00B





SHY-M001



SHY-M002



SHY-M003

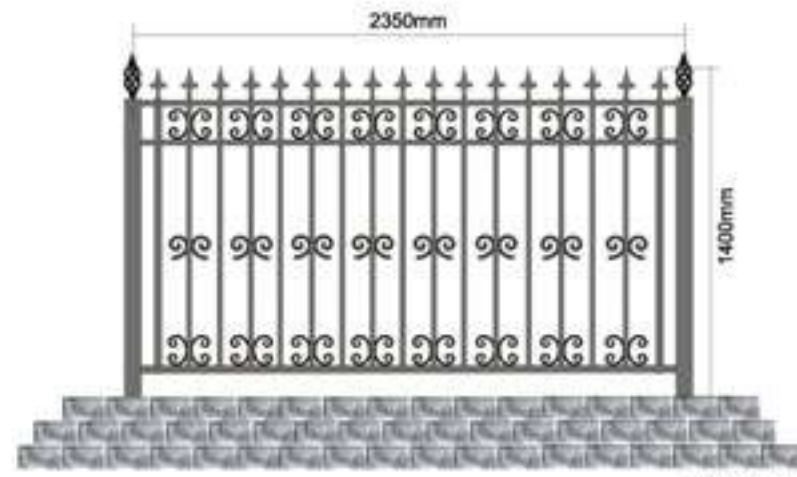

SHY-M004

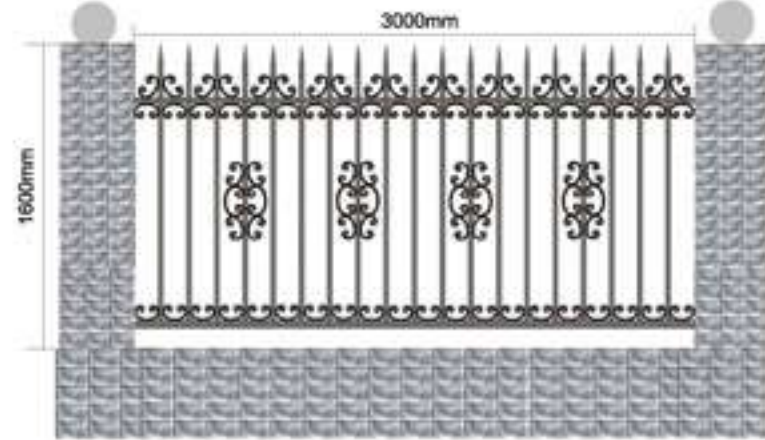

SHY-M005

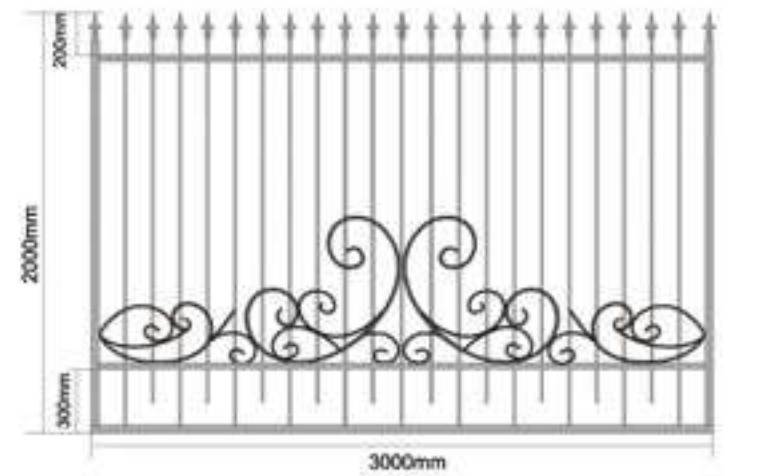

SHY-M006

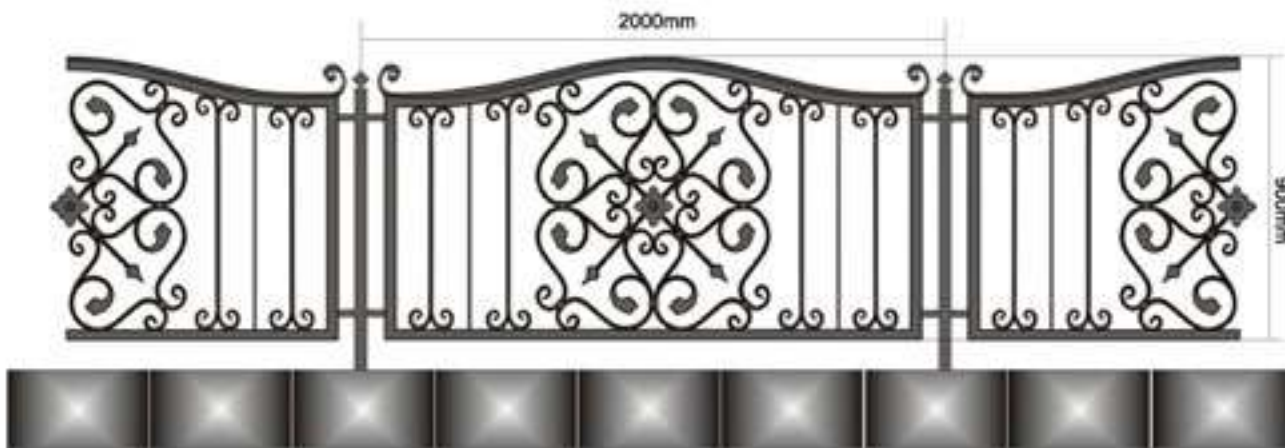

SHY-D007



SHY-M009

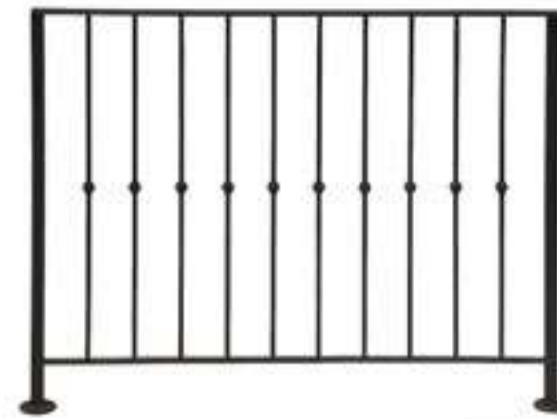

SHY-M008

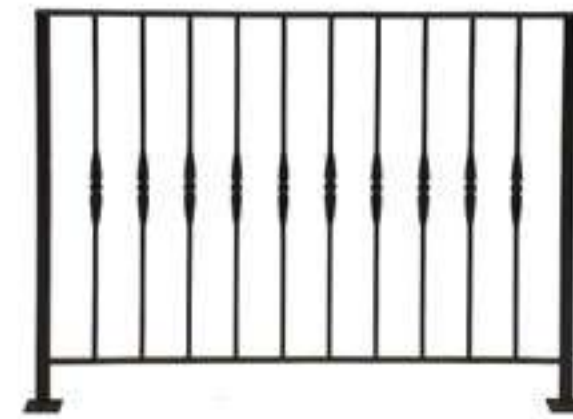

SHY-M010



SHY-M011

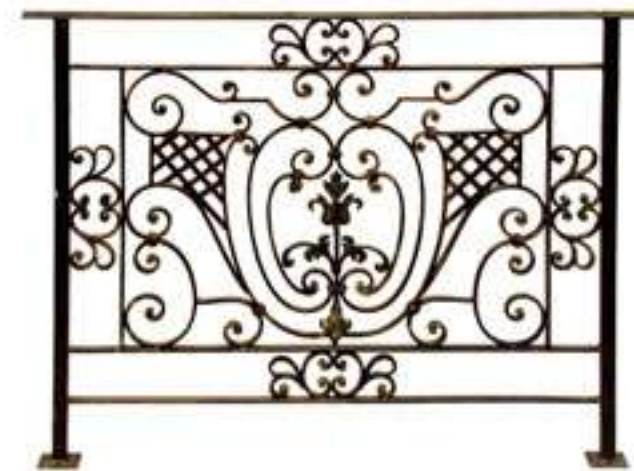

SHY-M012



SHY-M013



SHY-M014



SHY-M015



SHY-M016



SHY-M017



SHY-M018



SHY-M019



SHY-M020



SHY-M021



SHY-M022

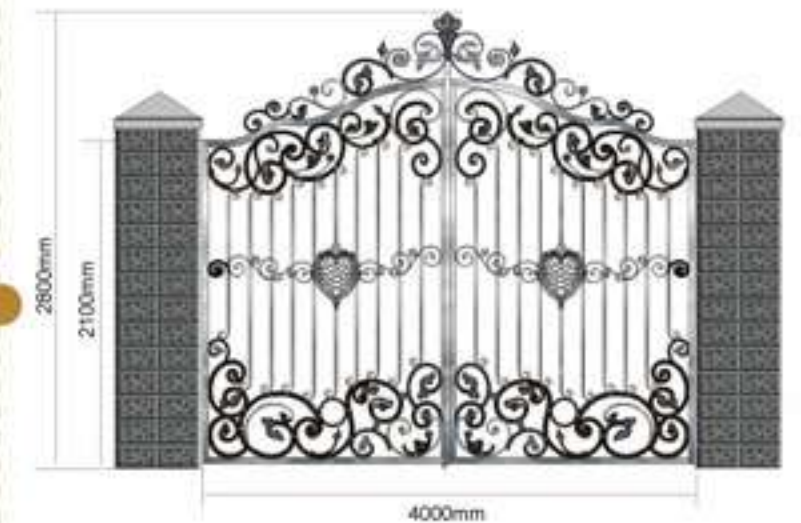

SHY-M024



SHY-M023



SHY-M025



SHY-M026



SHY-M027



SHY-M028



SHY-M029



SHY-M030



SHY-M031



SHY-M032



SHY-M033



SHY-M034



SHY-M035

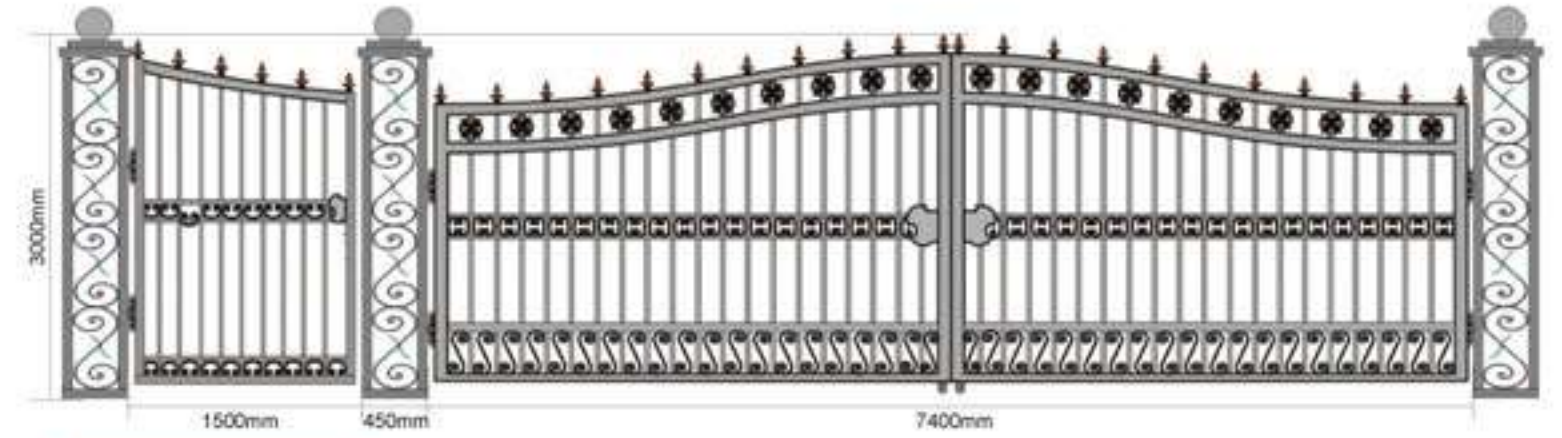

SHY-M036



SHY-M037



SHY-M038



SHY-M039



SHY-M040

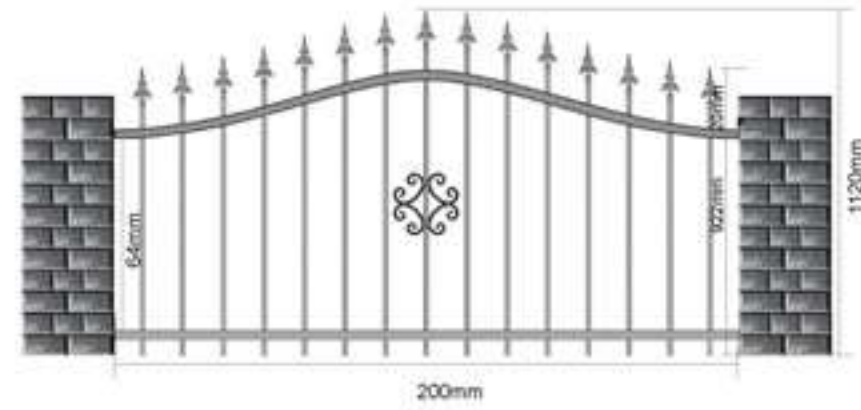

SHY-M041



SHY-M042



SHY-M043



SHY-M044

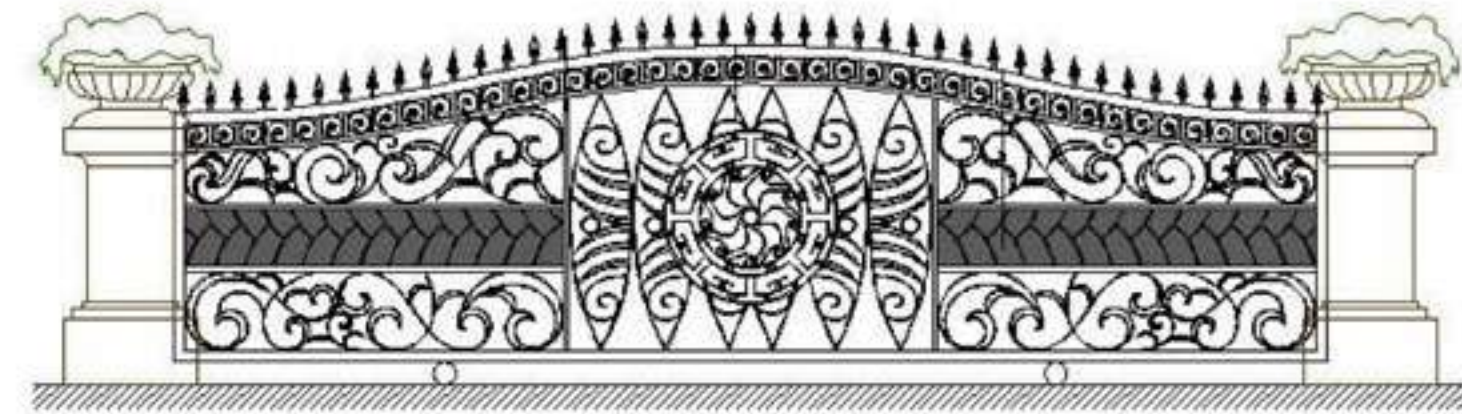

SHY-M045

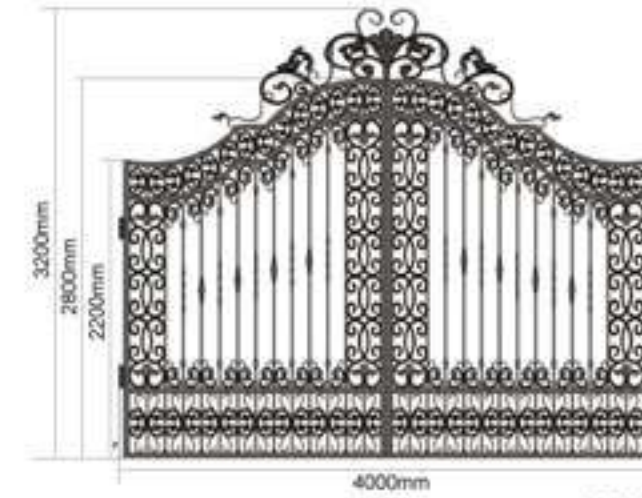

SHY-M046



SHY-M047



SHY-M048



SHY-M049



SHY-M050



SHY-M051



SHY-M052



SHY-M053



SHY-M054



SHY-M055



SHY-M056



SHY-P001



SHY-P002



SHY-P003



SHY-P004



SHY-P005



SHY-P006



03 STAIRCASE

Decorative Wrought Iron Railing/Staircase Railing

1. Combined with handcraft wrought iron components.

Cast steel fittings.

2. Anti-rust treatment; Hot Dipped Galvanize; Power

Coating

3. easily assembled

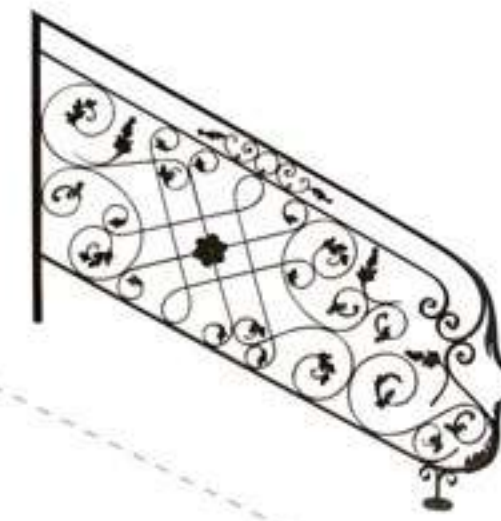

SHY-L001

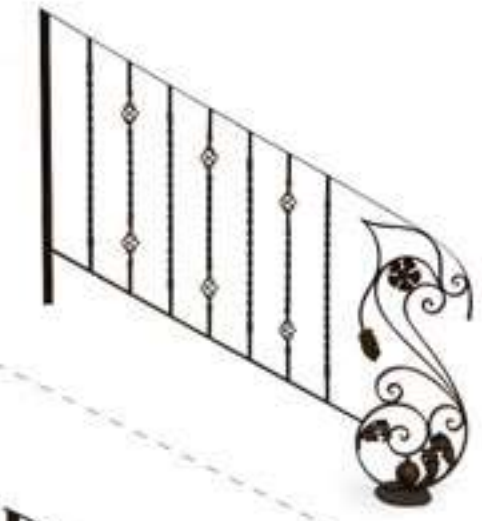

SHY-L002

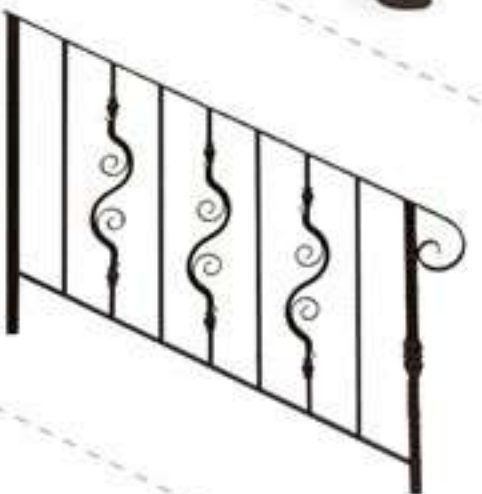

SHY-L003



SHY-L004

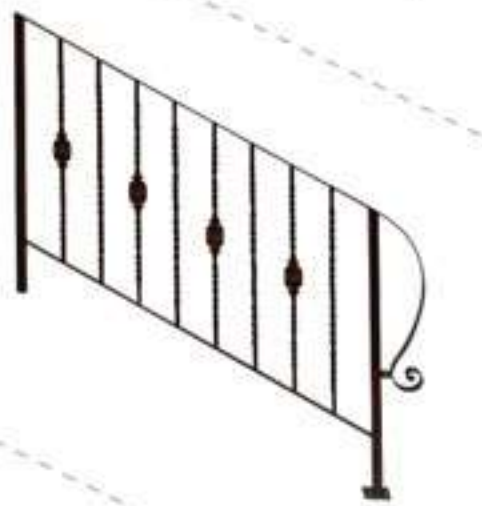

SHY-L005

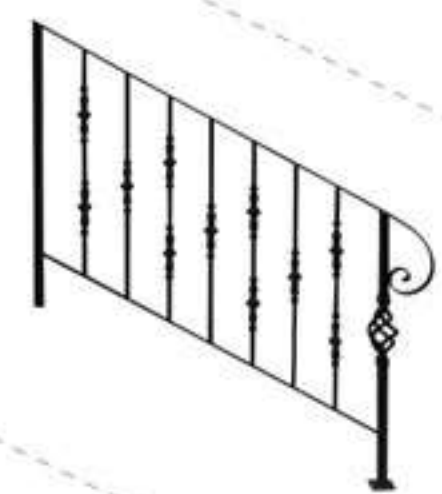

SHY-L006



SHY-L007



SHY-L008

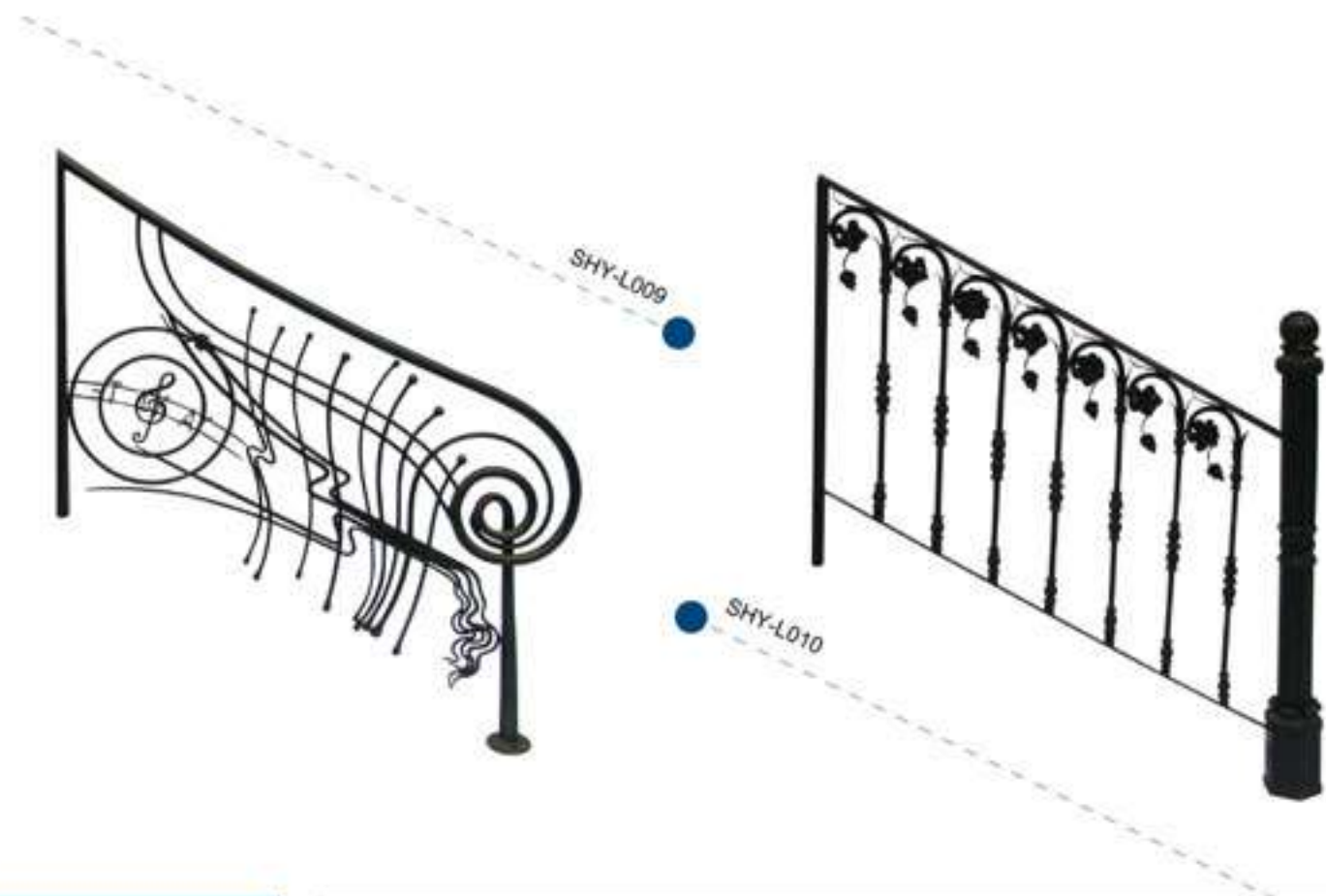

SHY-L011



SHY-L012

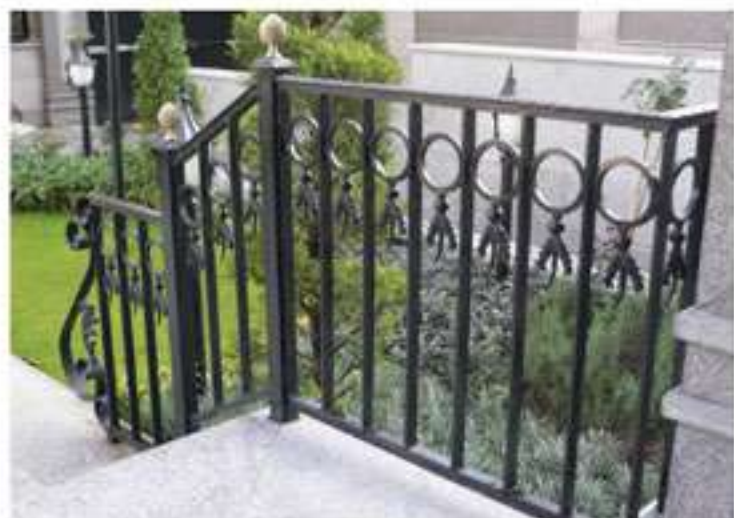

SHY-L013



SHY-L014

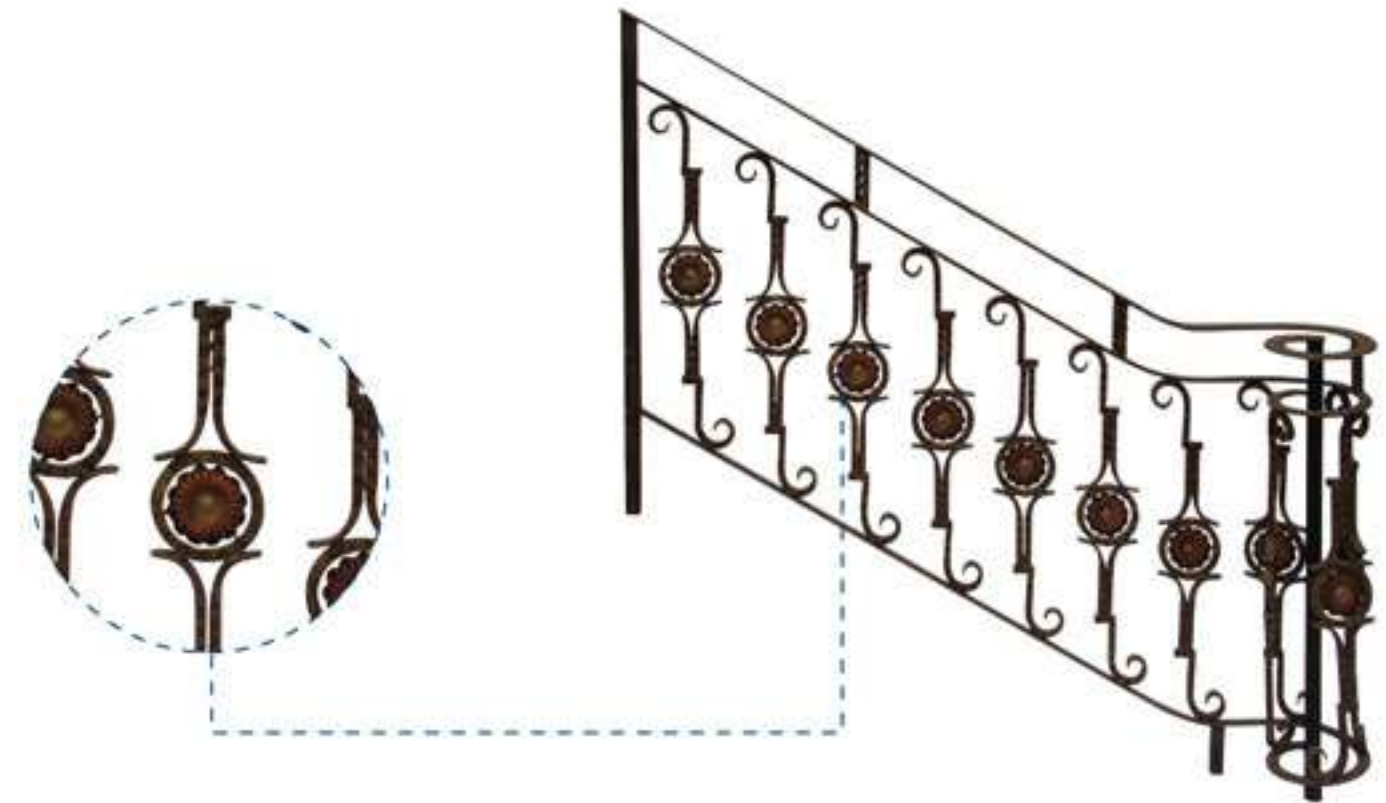

SHY-L015



SHY-L016



SHY-L017



SHY-L018



SHY-L019

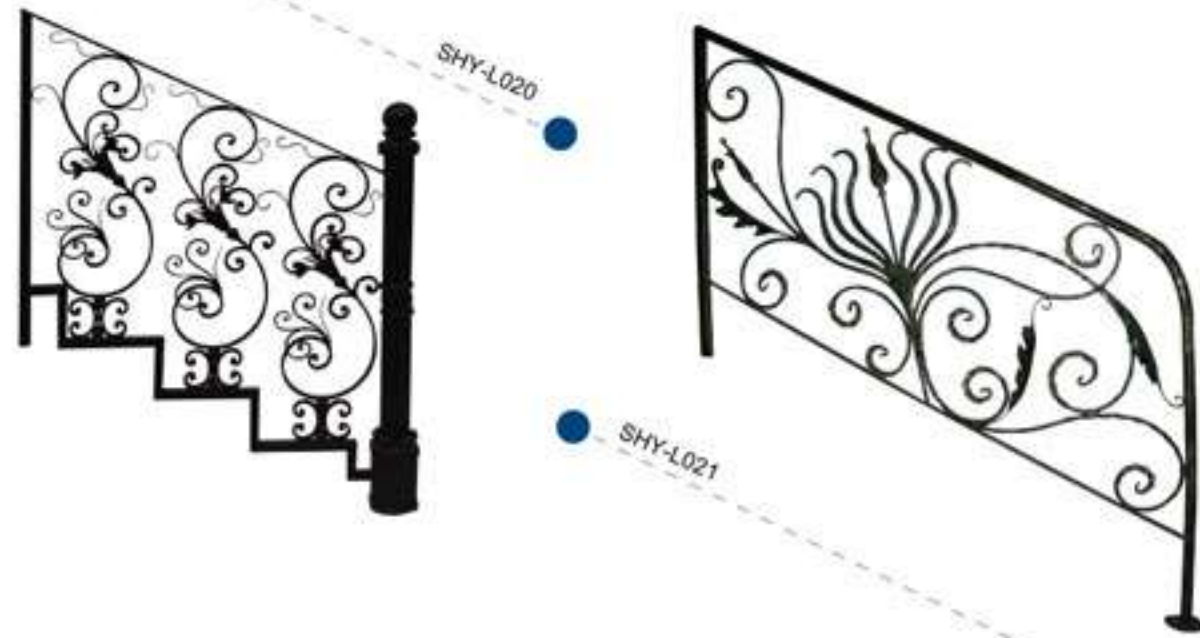

SHY-L022

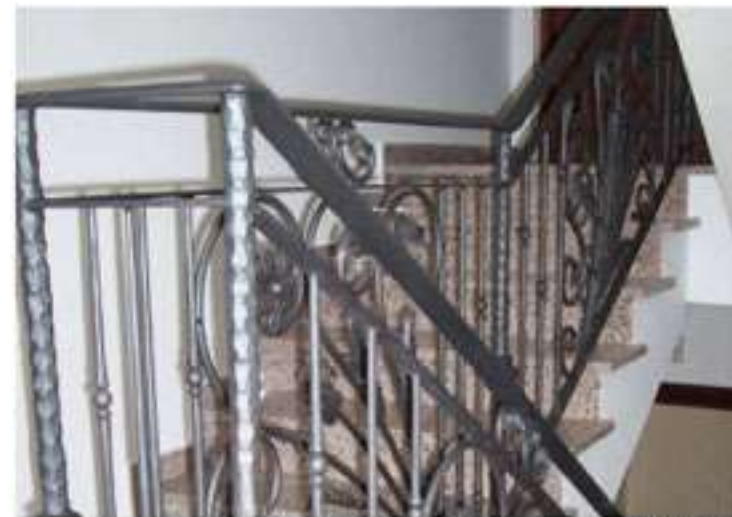

SHY-L023



SHY-L024



SHY-L025

04

STEEL FURNITURE

Material: Steel, Wrought Iron, Cast Iron

There are many features to choose from including design, color, and texture that complement any type of exterior.

While wrought iron ones give your home the

impression of elegance, wealth and style





SHY-Q001

SHY-Q002



SHY-Q004



SHY-Q006



SHY-Q005



SHY-Q003



SHY-Q009



SHY-Q007



SHY-Q008



SHY-Q010



SHY-Q012



SHY-Q011



SHY-Q013



SHY-Q014





SHY-Q015



SHY-Q016



SHY-Q017



SHY-Q018



SHY-Q019



SHY-Q020



SHY-Q021



SHY-Q022



SHY-Q023



SHY-Q024



SHY-Q025



SHY-Q026



SHY-Q027



SHY-Q028

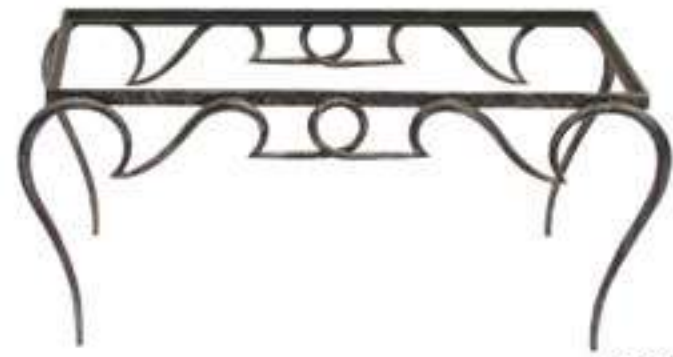

SHY-Q029



SHY-Q030



SHY-Q031



SHY-Q033



SHY-Q032



SHY-Q034



SHY-Q035



SHY-Q038



SHY-Q037



SHY-Q038



SHY-Q039



SHY-Q040



SHY-301
58X21

SHY-301B
58X21

SHY-302
45X14

SHY-303
58X19

SHY-304
50X13

SHY-305
58X16



SHY-306
50X19

SHY-307
50X14

SHY-308
40X11

SHY-309
40X10

SHY-313
45X15

SHY-360
58X18



SHY-001
330X270



SHY-002
100X100



SHY-003
120X60



SHY-004
125X115





SHY-6010
260X50X70



SHY-6011L
260X50X70



SHY-6011R
260X50X70



SHY-6012
260X50X70



SHY-6613
260X50X70



SHY-6617
290X40X110



SHY-6018
180X75



SHY-6019
355X75



SHY-M057



SHY-M058



SHY-M059



SHY-M060

Galvanized Rolling Wheels

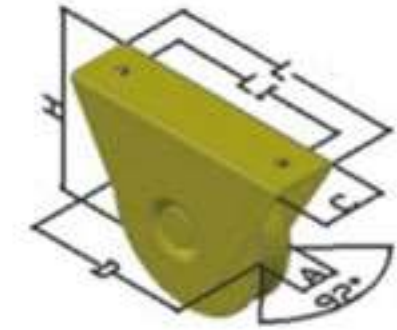

单位: mm

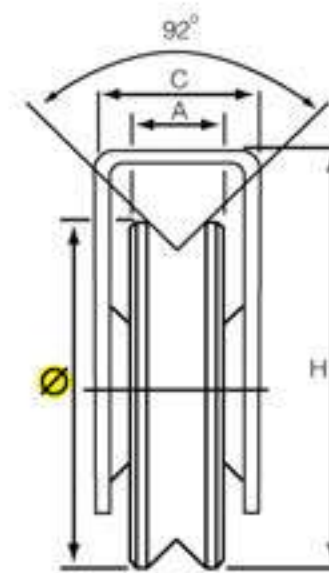

Product Code	D	A	C	H	L	L1
H-AV30	30	10	16	35	45	30.5
H-AV40	38	12	20	43.5	58	38
H-AV50	50	15	25	57	75	47
H-AV60	58	17	28	64	85	55
H-AV70	68	20	35	80	100	70
H-AV80	78	20	35	85	100	70
H-AV90	88	20	36	100	132	105
H-AV100	98	22	36	105	132	105

Welding Hinges



单位: mm

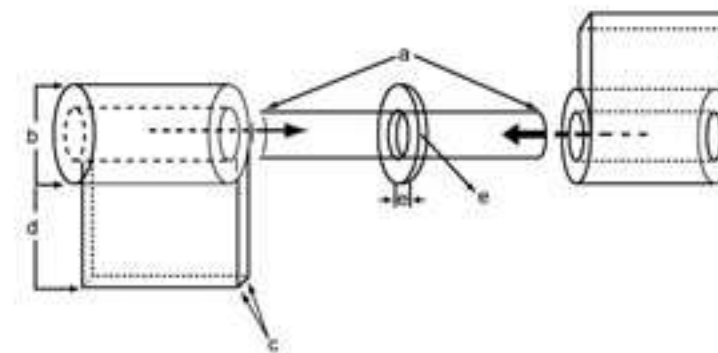

l _x b _x c	d	e
78.5x12x2.0	18	2.75
80x14x3.0	14	3.2
107x17x3.5	15	3
100x16.6x3.0	14	3.4
118x20x4.5	10	3.4
120x22x4.5	10	4
120x25x4.5	10	4
146x22x5.0	14	4.8



冷轧压花机
Cold Rolling
Embossing Machine



钢材切断机
Steel Cutting Machine



液压成型机
Hydraulic Moulder



二合一扭拧机
Two-In-One Torsion and
Twist Machine



铁艺高效加热器
The Power of Iron
Efficient Heater



燃气锻造烘炉
Gas Furnace



F3热轧鱼尾机
F3Type-Hot-Roll
Fishment Mill



电动滚卷机
Rolling coil Machine



电动弯花机
Electric Pattern Bender



电动弯花机
Electric Pattern Bender



立式可调加强型弯管机
Upright Adjustable
Reinforcement Pipe Bender

